

## DEVELOPMENT OF FUNDAMENTALS IN PHYSICS

**G. Takeda**

*The University of Tokyo and Tohoku University, Sendai, Japan*

**Keywords:** Newton's law of motion, mass, force, acceleration, universal gravity, Kepler's laws of planetary motion, energy and work, Hamilton formalism, Lagrange formalism, conservation laws of linear and angular momenta, laws of thermodynamics, pressure, temperature, the equation of state, internal energy, heat capacities, entropy, Carnot cycle, kinetic theory of gases, Maxwell-Boltzmann distribution, wave theory of light, reflection, refraction, interference, Huygens' principle, double slit experiments, sound, group velocity, phase velocity, Doppler effect, magnetism, electricity, Coulomb's law, Ohm's law, electric and magnetic fields, lines of force, Biot-Savart's law, electromotive force, electromagnetic induction, electric polarization, electric displacement, Maxwell's equations, paramagnetism, diamagnetism, ferromagnetism, electromagnetic potential, Aharonov-Bohm effects.

### Contents

1. Introduction
2. Newtonian Mechanics
  - 2.1. Position, velocity and acceleration
  - 2.2 Newton's equation of motion
  - 2.3 Energy and work
  - 2.4 Hamilton formalism
  - 2.5 Lagrange formalism and the principle of least action
  - 2.6 Rotational motion
  - 2.7 Kepler's laws of planetary motion
  - 2.8. Units of physical quantities
3. Thermodynamics and Heat Transfer
  - 3.1 Temperature and pressure
  - 3.2 Heat and Heat Transfer
  - 3.3 The first law of thermodynamics
  - 3.4 Thermal properties of gases
  - 3.5 Thermodynamics
  - 3.6 The second law of thermodynamics
  - 3.7 The kinetic theory of gases
4. Principles of Optics and Acoustics
  - 4.1 Principles of optics
  - 4.2 Principles of acoustics
  - 4.3 Propagation of sound
  - 4.4 Group velocity, phase velocity, and the Doppler effect
5. Electricity and Magnetism

- 5.1 Electricity
- 5.2 Magnetism
- 5.3 Electrostatics and magnetostatics
- 5.4 Relation between electricity and magnetism
- 5.5 Unification of electricity and magnetism
- 5.6 Vector fields and vector calculus
- 5.7 Energy of electromagnetic fields
- 5.8 Unification of the electromagnetism and the optics
- 5.9 Electromagnetic potentials
- 5.10 Systems of units
- Acknowledgements
- Glossary
- Bibliography
- Biographical Sketch

## Summary

Classical physics covers vast areas in physics such as mechanics, thermodynamics, acoustics, optics, and electricity and magnetism. Basic concepts and equations in these fields are presented in this chapter. A basic concept in physics is hard to formulate in a rigorous manner and the concept will be deepened and revived with the progress of physics. As an example, we describe how the basic concepts in Newtonian mechanics are formulated and deepened. Newton's equation of motion is the first genuine law of physics which is universally valid for motion of bodies including motion of planets. Also the law of gravity by Newton applies for any pair of bodies. It has become gradually realized that the fundamental laws of physics are quite universal.

In thermodynamics, basic concepts such as temperature, pressure, internal energy and entropy are presented together with equations of state which relate these thermodynamical quantities to one another. The first and second laws of thermodynamics are the basic laws of physics which govern all thermodynamical processes. It is noted that thermodynamics is formulated without referring to any particular microscopic model of matter, but through careful observations and experiments. Acoustics and optics are subjects which are quite intimate to our daily living. Both optical and sound waves exhibit common phenomena such as reflection, refraction, diffraction and interference phenomena. Some basic concepts in acoustics and optics are presented. A sound wave is a compressional density wave through matter while an optical wave is a wave of electromagnetic field itself through space, even space without matter.

Basic concepts and phenomena in electricity and magnetism are presented in this chapter. They were originally separate phenomena in physics, but it was found that they are mutually related through phenomena such as electromagnetic induction. Finally they are unified as Maxwell's equations by which all electric and magnetic phenomena can be understood. Also optical waves turned out to be electromagnetic waves, so that optics and electromagnetism are unified.

## 1. Introduction

If we were asked to mention one person contributing most to the foundations of modern physics, most of us will choose Isaac Newton (1642-1727). Newton was a physicist who represented the physics society in England as well as European Continent during the 17<sup>th</sup> and 18<sup>th</sup> centuries. He formulated the basic laws of motion of matter and discovered the universal gravitational force acting between any two bodies and the inverse square law of gravity. He also formulated his theory of light in his book 'Optics' (1704), in which he emphasized that light is corpuscular in nature. It is really remarkable that all the laws and concepts founded by Newton are still valid even now without much modification, offering us the basis of modern physics as well as science in general. Newton's great treatise "*Philosophiae Naturalis Principia Mathematica*" (The mathematical principles of natural philosophy) published in 1687, known as the *Principia* for short, summarized his achievements on the laws of motion and gravity, which might be called the first genuine text book in physics as we know it today. Since the study of the history of science has become popular these days, a large amount of literature on the *Principia* has become available to us now and one can study the great works of Newton through these. However, the *Principia* itself is not an easy book to understand and only very few people probably had really read through and understood the *Principia* until today. In spite of *Principia* being a difficult book to understand, Newton's fame and authority led his earnest followers to understand his ideas and works, reform his formulations and concepts in more transparent manners, and develop his works further. As a result, people had succeeded in formulating a basic framework of mechanics which is called the classical or Newtonian mechanics.

In the beginning of the 20<sup>th</sup> century, Newton's laws of motion were replaced by Einstein's theory of special relativity when we have to deal with objects moving very fast comparable to the velocity of light. Also the origin of gravitational force was explained by Einstein's theory of general relativity. Furthermore, quantum mechanics born in the early 20<sup>th</sup> century replaced classical mechanics when we deal with microscopic objects of atomic scales. However, classical mechanics is still valid with a very good accuracy in most physical phenomena except those in which we have to deal with microscopic objects or fast moving objects. One of the milestones in our heritage through the history of natural science, which had great influence on Newton's works, is Euclidian geometry. '*The Elements*' written by Euclid (330-275 B.C.) comprised 13 books which summarized and organized the mathematical knowledge developed in the preceding centuries. In particular, it included knowledge on plane and solid geometries. *The Elements* might be the most valuable writing in natural science before the *Principia* and its contents clearly showed us a very high level of the natural philosophy of the ancient Greek culture. *The Elements* had served as the basic text book in mathematics for almost the next 20 centuries, and most of the contents in the Elements are remarkably well valid even now.

In geometry a certain set of axioms is presented first, as the starting point for geometry. One has to accept each axiom as a correct one without asking any reasoning for it. In other words, one must simply accept the set of axioms. Based on it, one proceeds in a sequence of logical steps leading to various useful theorems. Then, each specific problem in geometry will be solved by making use of the theorems through strictly logical processes. The aggregate of the logical steps leading to the solution is called

'proof'. There are many equivalent choices as a set of axioms of Euclidian plane geometry. For example, we can adopt the following set of axioms:

1. There exists always one and only one straight line segment to connect any two points in a plane and it can be extended further to any distance beyond the two points.
2. One can draw a circle with any given radius about any point in a plane as the center.
3. Any two right angles are the same, because the two angles can be perfectly made to overlap with each other by moving them in the plane.
4. One can draw always one and only one straight line through any point which is parallel to any given straight line in a plane (the parallel postulate).

As we can see in Fig. 1, all the axioms state very simple facts which we do know through our experiences and one can easily accept them. However, if we were asked to give reasons for them, it will not be easy except to say that they are true if one practices what the axioms say. Axioms are statements given *a priori* and one is not required to offer reasoning for them.

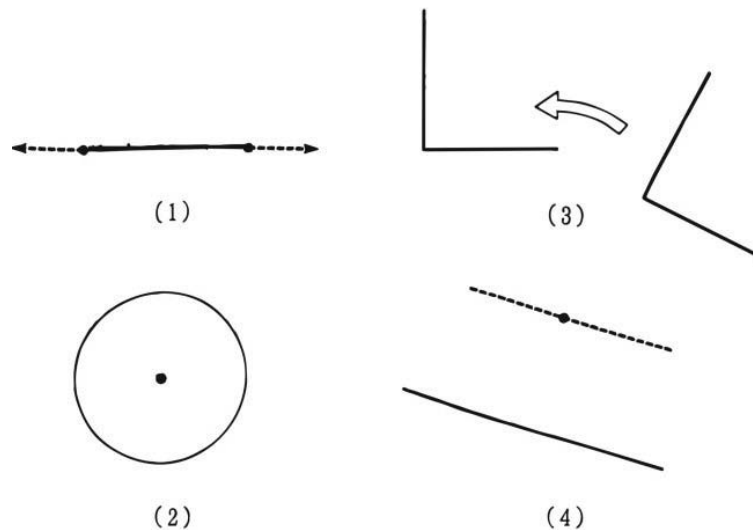

Figure 1. Axioms of Euclidean plane geometry

Starting from a set of axioms, one can derive various theorems of Euclidian geometry through procedures called proofs. For example, we can prove that the three medians of any triangle meet at one point. Likewise, the three perpendiculars meet at one point. These are examples of theorems in plane geometry. We can easily find that the theorems are true if we make drawings of the lines of a triangle as shown in Fig. 2. However, those who have never tried to draw the lines may not be convinced of the truth of the theorems.

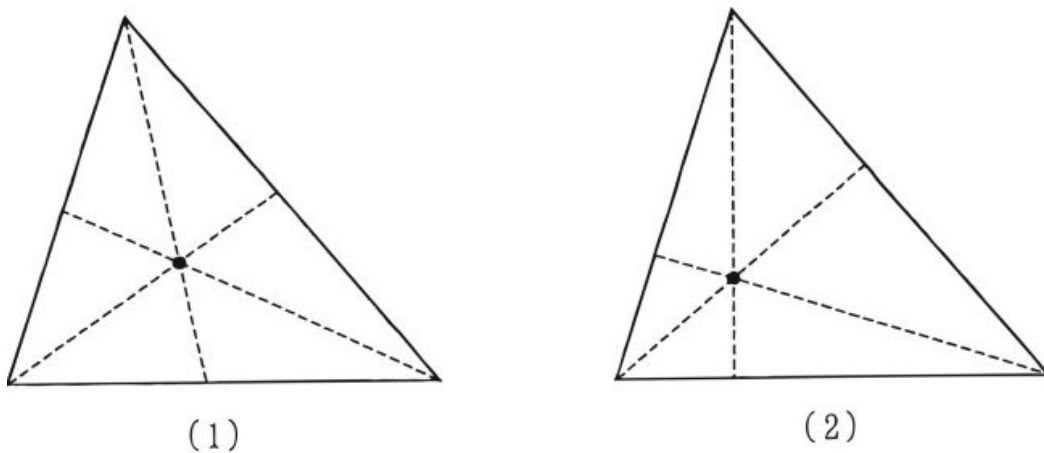

Figure 2. Theorems of three medians and three perpendiculars

Unlike axioms, theorems state facts which are *a priori* not so obvious to most people. Also it is rather a difficult task to derive theorems from the set of axioms even for a trained person in mathematics. It is really remarkable that theorems can be derived only through logical deduction from the set of the simple and innocent looking axioms, thus showing us the great power of logical thinkings of mankind. There is freedom in the choice of a set of axioms. One should better choose axioms which appeal most to our commonsense. Also, the axioms should not be mutually contradictory to one another and a set of axioms must be sufficient to specify the geometry.

In writing the *Principia*, Newton tried to present his assertions in a style similar to the writing of *The Elements*, so that he could avoid the anticipated criticism from his opponents and the presentation would be most persuasive for readers. Newton's laws of motion and the law of universal gravity correspond to a set of axioms in geometry. From these basic laws, Newton was able to derive the motion, of planets about the sun, of the moon about the earth and of various bodies on the earth. These were derived only through entirely logical steps from the laws of motion and gravity, just like various theorems in geometry were derived through logical steps from a set of axioms of geometry. Thus, it was shown that bodies on the earth and stars in the sky are both governed by the same laws of motion and gravity, providing us a unified view of motion of matter in our universe. Newton's attitude was that the basic laws in physics are simply stating facts of experiences just like axioms in geometry and that the laws of motion can be obtained only through careful observation of motion of bodies. This pragmatic attitude was the key to his success in formulating the basic framework of classical physics, thereby avoiding metaphysical controversies likely leading to nowhere.

Newton's three laws of motion are as follows:

Newton 1. Every body continues in its state of rest or of uniform motion in a straight line except in so far as it is compelled by forces to change that state.

Newton 2. The rate of change of motion (i.e. momentum) is proportional to the force and the change of motion takes place in the direction of the straight line in which the force acts.

Newton 3. To every action there is always an equal and opposite reaction; or the mutual actions of any two bodies are always equal and oppositely directed along the same straight line.

The first two laws can be combined into the following equation, which is called Newton's equation of motion;

$$m\mathbf{a} = \mathbf{f} \quad (1)$$

Here  $m$  is the inertial mass of a body usually referred to as 'mass' for short,  $\mathbf{a}$  is the acceleration of the body which is the rate of change of velocity when the body is moving, and  $\mathbf{f}$  is a force acting on the body. If we use the momentum  $\mathbf{p}$  which is equal to mass times velocity  $\mathbf{v}$  ( $\mathbf{p} = m\mathbf{v}$ ), Newton's equation of motion is

$$d\mathbf{p}/dt = \mathbf{f} \quad (2)$$

where  $d\mathbf{p}/dt$  is the time derivative of  $\mathbf{p}$ , i.e. the rate of change of momentum in time.

According to Newton, every physical phenomenon could ultimately be explained by mathematical laws, an approach to physics which has been well inherited up to the present days. It is remarkable that Newton's equation of motion which looks so simple can yet give an accurate description of motion of falling bodies on the earth as well as the motion of bodies in celestial space, if we use the universal gravitational force found by Newton as the force acting upon the bodies. In spite of the great achievements of Newton and the mathematical simplicity of Newton's equation of motion, it may require great intellectual effort to understand what Newton's equation of motion really means. In general, there are conceptual and logical problems which are inherent in any physical law. Since Newton's equation of motion is a good example to show that any physical law is the result of very intelligent works of scientists, let us examine the physical contents of Newton's equation of motion in some detail.

There are logical as well as conceptual problems about definitions of physical quantities appearing in Newton's laws of motion. First, each of the physical quantities, mass, acceleration or force, must correspond to a certain concept which is preferably accessible to our intuition. Second, for the quantities to be subjects, worthy of scientific investigation, we can quantify them as numbers if necessary and certain objective methods must be available for us to measure them, so that everybody can get the same values for them. Third, the three quantities, mass, force, and acceleration, should be defined independently from one another and should also be independently measurable, thus assuring us that each of them corresponds to a different physical concept. This last requirement is very subtle, exemplifying a typical feature of the concept formation process in physics as we shall see later. If all the above requirements are met, Newton's equation of motion indeed relates the three physical quantities which are independently defined and quantified and correspond to different physical concepts. Thus the equation is entitled to be called as a natural law in physics.

Mass is a proper attribute for an object and is accessible to our senses. When we lift up or hold a body, we can feel whether it is light or heavy through our somatic sense. When we lift up a bottle filled with water, our sense of weight depends on the bulk of water. Through our somatic sense we could even infer that the mass of water is proportional to the bulk of water. In this case we are assuming uniformity of water and additive property of mass, i.e. the mass of the whole being the sum of the masses of the parts. The additive property of mass is implicitly contained in the concept of mass expressed by the simple notation  $m$ .

Newton's equation of motion can be used to define and quantify mass. Suppose we have two bodies with masses  $m_1$  and  $m_2$  colliding with each other. Newton's third law of motion states that the two bodies are acted upon by equal and oppositely directed forces, and then Eq. (1) tells us that  $m_1\mathbf{a}_1 = -m_2\mathbf{a}_2$  where  $\mathbf{a}_1$  and  $\mathbf{a}_2$  are the accelerations due to the collision. Thus, we obtain  $m_1/m_2 = -\mathbf{a}_2/\mathbf{a}_1$ . If we choose one of the masses as a standard, we can determine the mass of the other through measurements of the ratio of the accelerations of the two bodies in the collision.

If the two objects are composed of the same material, we can confirm through their collisions that the mass of an object is proportional to the volume of the object. Once proportionality is established, the mass of an object can be calculated by knowing the mass of a unit volume of the material without referring to Newton's equation of motion anymore. The ratio of masses of objects composed of different materials has to be determined first through collisions of the two objects or through some other appropriate experiments. But, again once the ratio is determined, the mass of an object which is a mixture of the two materials can be calculated without referring anymore to the equation of motion. In this way, mass becomes a quantity which can be independently defined and quantified from acceleration and force.

We might mention that there are two kinds of mass, the mechanical mass and the gravitational mass. The former is the one appearing in Newton's equation of motion and the latter appears in the law of gravity. They are conceptually different, but numerically the same in an accuracy up to one part in  $10^{12}$  as we know now. This remarkable coincidence was one of the key ingredients in Einstein's theory of general relativity (*see Physical Systems and Laws* ).

Next we shall consider acceleration. Concepts of position and velocity of an object are well known to all of us at least intuitively through our visual perception of a moving body. Acceleration is perhaps less familiar than position and velocity, but yet it is a quantity accessible to our senses. One can feel velocity change of a moving body through our visual sense. In our modern life one can even notice an acceleration caused by a sudden change of speed through our somatic sense when we are riding on a fast moving vehicle.

In order to trace quantitatively the trajectory of a moving body, one must have some scales and clocks to measure spatial and temporal distances and must set up an appropriate space-time coordinate frame of reference. Then the position of a body at a given time is specified by the distance of the body from the origin of the reference frame.

Our space is three dimensional having three directions; up and down, left and right, and forward and backward. We must determine the position of a body by measuring distances away from the origin in each of the three directions. Thus, the position is a vector quantity having three components, each of them denoting the distance in the respective directions. Likewise, velocity and acceleration are vectors in the three dimensional space. We shall denote a vector quantity by a bold letter as we have already employed bold letters **a** and **f** for acceleration and force respectively.

For setting up a frame of reference, we must have some *a priori* knowledge on our space-time structure and some devices for measuring spatial distances and time intervals. In *The Principia*, Newton took an attitude that the space-time concept is well known to everybody and does not need explicit elaboration.

In the social and scientific circumstances of his time this pragmatic attitude of him perhaps was the best for avoiding all kinds of controversies expected to arise then. Newton carefully separated what one can argue at his time from those too early to argue. Today, our knowledge of the space-time structure has greatly exceeded our simple intuitive knowledge of it mainly due to Einstein's theory of relativity.

Since the space-time structure of our universe is assumed to be known *a priori* in Newtonian mechanics and scales and clocks to measure spatial distances and time intervals are available, acceleration is a quantity which can be defined and quantified independently from mass and force. Namely, velocity is the measure of how much distance a body travels in a unit time in some particular direction and acceleration is the measure of change of velocity in a unit time.

Newton thought of moving bodies as possessing different amounts of motion called "quantity of motion", which is the product of the mass and the velocity. Today, this quantity of motion is called momentum. Newton correctly recognized that momentum is a more essential quantity than velocity to describe the motion of bodies, and change of momentum rather than change of velocity is directly related to forces acting upon the bodies.

Last, we shall discuss what force is. When we push a body or a body hits us, our somatic sense tells us that either we exerted a certain force on the body or we were acted upon by a certain force from the body. These are forces acting between two bodies touching each other. However, a force like gravity acts between two bodies apart, which is called action at a distance. Such a force is hard to sense and does not easily appeal to our somatic sense. All of us are being attracted towards the center of the earth by its gravity, although we cannot feel existence of the gravity. Electromagnetic forces are also actions at a distance and it is also hard for us to sense them. This is why we needed the genius of Newton to discover the universal gravitational force.

Although some forces could appeal to our somatic sense, they are difficult to quantify. Since we know that a body must change its velocity under the action of a force, thanks to Newton's laws of motion, we can use the rate of velocity change times the mass or the rate of momentum change as a measure of the strength and direction of the force. In this way we can convert a degree of subjective sense into an objective measure of the force.



If we adopt always this procedure, Newton's equation of motion becomes an equation to define force in terms of the product of mass and acceleration, i.e. the change of momentum. Then force would become a physical quantity not being independent from mass and acceleration, and Newton's equation of motion becomes an equation to define force in terms of mass and acceleration. We shall see later that this is not the case.

According to Newton's second law of motion, any acceleration of a moving body implies existence of a force. Since any freely falling body falls towards the center of the earth with increasing velocity, we can infer that a universal attractive force (gravity) due to the earth exists which acts on any matter irrespective of its nature. Galileo (1564-1642) studied for the first time the motion of falling bodies quantitatively. He confirmed that any body irrespective of its shape, mass, and kind falls exactly in the same way with the same acceleration towards the earth. Of course, if we drop a light object such as a sheet of paper, it will fall down slowly and swinging due to frictional forces by air. In the modern days we can evacuate a large vessel and see how various bodies fall inside it. As expected, all bodies fall exactly in the same way getting the same acceleration due to the gravity of the earth.

The same acceleration for any falling body irrespective of its mass and Newton's equation of motion together imply that the strength of the gravitational force is proportional to the mass of the falling body. If gravity is a universal attractive force acting between any two masses, we could also infer that the strength of the gravity due to the earth must be proportional to the mass of the earth. Newton's law of universal gravity is as follows:

1. There exists a universal attractive force between any two masses and the direction of force is along the line connecting the centers of the masses.
2. The strength of the attractive force between masses  $m$  and  $m'$  separated by a distance  $r$  is

$$f = Gmm'/r^2 \quad (3)$$

where  $G$  is the universal gravitational constant.

Then, the gravitational acceleration for a body on the earth is given by  $g = GM/R^2$ , where  $M$  is the mass and  $R$  is the radius of the earth. Numerically  $g$  is about  $9.8\text{m/s}^2$ . With the constant acceleration  $g$ , the velocity of a falling body is given by  $v = gt$  and the falling distance is  $s = (1/2)gt^2$ , where  $t$  is the time elapsed since the body started falling down. The falling distances for first few seconds are shown in Fig. 3.

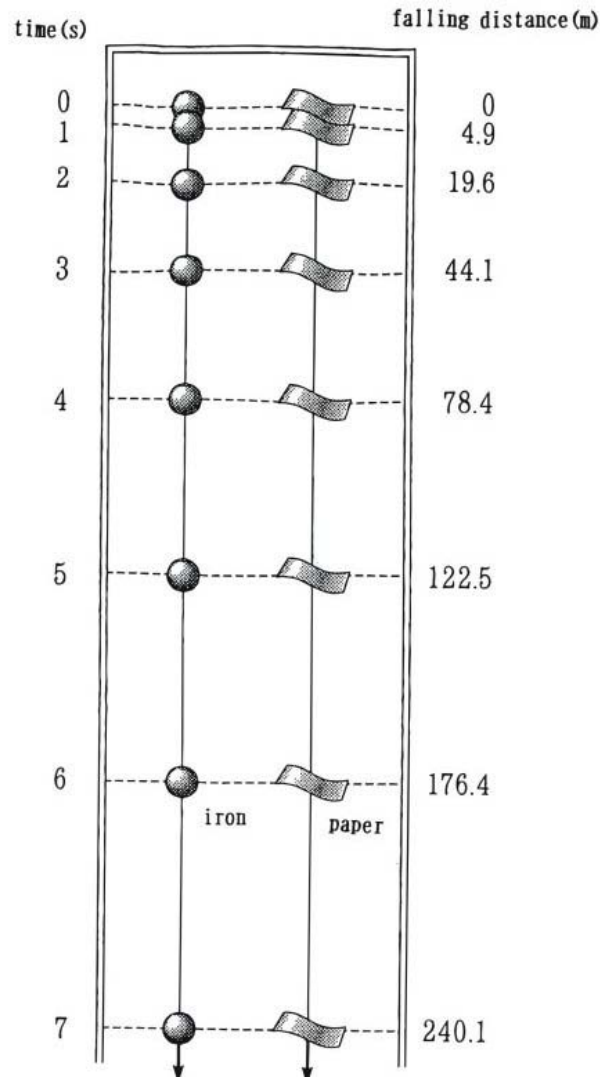

Figure 3. Free fall of various bodies in an evacuated vessel

The masses appearing in Eq. (3) are called gravitational masses, which determine the strength of the gravity. The mass appearing in Newton's equation of motion is called mechanical mass, and larger mechanical mass implies larger inertia for changing velocity of the body under the action of a force. Therefore, the two masses are conceptually quite different, but it is known that they are numerically the same to an extremely good accuracy.

It is instructive to know how Newton speculated that the gravitational force between two bodies is proportional to the inverse of the square of the distance  $r$  between them. The moon moves about the earth with a period of approximately 28 days. The distance between the earth and the moon is about 60 times as large as the radius of the earth, which was known already at Newton's time. As we often say that the moon rises or falls in our daily conversations, Newton wondered whether one could consider the moon as falling towards the earth due to the gravity of the earth in spite of the distance between them being constant during the revolution of the moon about the earth.

Figure 4 shows the distance  $h$  by which the moon falls when it moves from one point to another along its circular orbit about the earth in a given time interval. One can easily calculate  $h$ , since we know the radius of the orbit and the period of revolution of the moon about the earth. In one second the moon falls a tiny distance  $h$ , which is about equal to  $(4.9/3,600)\text{m}$ . This value should be compared to the falling distance 4.9m of a body on the earth in the first one second.

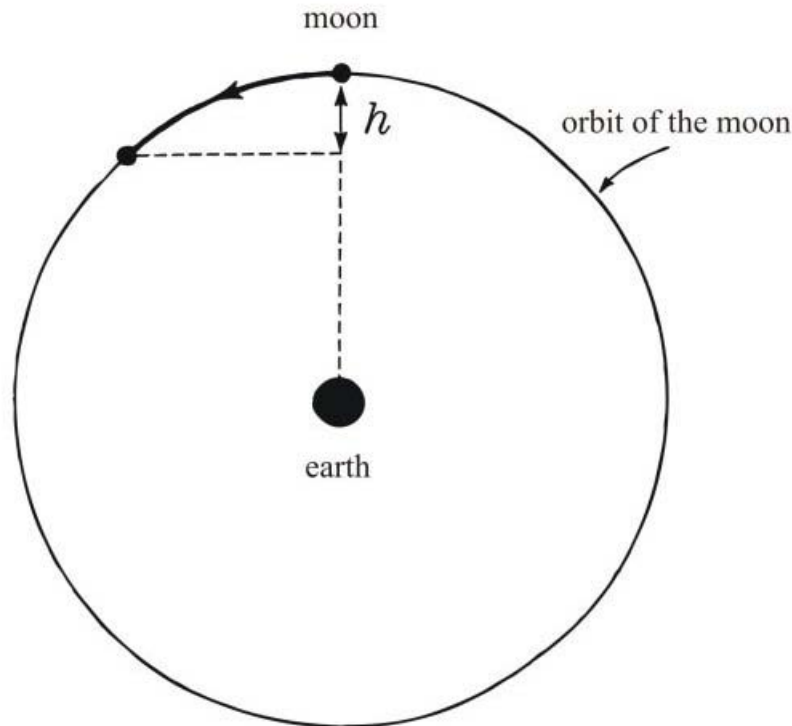

Figure 4. Revolution of the moon about the earth

The moon falls down  $1/3600$  times as much as a body on the earth. This means that the acceleration is less for the moon than for a body on the earth's surface by a factor of  $1/3600$ , which is  $1/60$  squared. From the fact that 60 is about the ratio of the distance between the moon and the earth to the radius of the earth, Newton speculated the inverse square law of gravity. The distance and the radius were only roughly known at Newton's time, and thus it was impossible for him to derive the inverse square law only through these observations. In fact, Newton obtained a factor  $1/4000$  instead of  $1/3600$ .

A conviction that natural laws should take a simple mathematical form might have helped him to guess the exact inverse square law of gravity. But the decisive reason for him to propose the inverse square law was that he could derive Kepler's laws of motion of the planets moving about the sun, only if the gravitational force is exactly proportional to the inverse square of distance between the sun and the planet (see *Development of Fundamentals in Physics - Newtonian Mechanics*).

The law of gravity (Eq.(3)) has been constantly examined with increasingly improved accuracy. Although gravitational force between two terrestrial bodies is very weak because of their small masses, the inverse square law was confirmed even in laboratory experiments. Up to now the law has been proved with an extremely good accuracy,

although some physicists speculate that a small deviation from the inverse square law might be still possible at extremely short distances of a subatomic scale. So far there has been no evidence against the inverse square law of gravity.

Now we shall return to discuss the conceptual problems inherent in Newton's equation of motion. In the beginning of studying free falls of various bodies, we estimate the strength of a force exerted on a body as the product of the mass and acceleration of the falling body. Namely, we define and quantify the force by using Newton's equation of motion. As we proceed, we find some universal properties of the force such as the strength of the force being proportional to the masses of interacting bodies and to the inverse of the square of distance between them. Thus, the gravitational force gets the status of being a universal force which acts between any two bodies with strength given by Newton's law of universal gravity.

Once its universal properties were established, force got the status of a physical quantity independent from mass and acceleration and it can be quantified without referring to Newton's equation of motion anymore. At the same time, Newton's equation of motion becomes qualified as a natural law which relates the three independently defined and quantified physical quantities, mass, acceleration, and force, and not a mere entity to be defined in terms of the product of mass and acceleration. In general, when we meet an unknown force, Newton's equation of motion will be used as an equation to define the force. As we reveal the properties of a force and gradually realize their universal nature, the force becomes a quantity having its own proper concept and being independently quantified from others. As a result, Newton's equation of motion becomes qualified as a natural law.

Today we know four kinds of fundamental force - gravitational, electromagnetic, strong and weak forces ( *see Particles and Fields – Types of Interactions* ) . The electromagnetic and weak forces are even unified into the electroweak force and the two forces can be regarded as different manifestations of the same electroweak force. Further unification of the different fundamental forces has been actively sought after. The universality of forces must be essential in establishing the concept of force independent from concepts of other physical quantities such as mass and acceleration and in promoting Newton's equation of motion up to the basic natural law in physics.

We have described in some detail the conceptual and logical problems inherent in Newton's equation of motion as a typical example to show how concepts of various physical quantities being formed and what a natural law means to us. We use a natural language to communicate with one another in our daily life. Each word used in conversation has a certain underlying concept associated with it. When we make a sentence composed by words, the meaning of each word in it depends subtly upon the composition of the sentence as a whole. The meaning of a word or a sentence also depends subtly upon social circumstances as well as personal experiences of speakers. If conversation is really an expression of our mind, in each word or sentence used there should appear some reflection of personal feeling and psychological condition of the speaker.

The same is also true in physics as well as natural science in general. It is wrong to regard physics as exceptionally lacking in individuality of people who explore it. Physical quantities and symbols which appear in Newton's equation of motion are similar to words in natural language. Although there exists a certain common concept for each physical quantity or symbol, the concept might depend subtly on the intuition and the amount of knowledge of people who study the quantity or use the symbol.

On the other hand, the fact that many people can share almost the same intuitive interpretation of a physical quantity or a symbol means that we have developed common devices in our brain to understand physical phenomena and laws through the evolution of human species. Furthermore, in a natural science, one tries to present physical concepts in objective ways as much as possible without referring to personal intuitions, and to use certain objective methods to quantify physical quantities and symbols. How to understand Newton's equation of motion seems to offer a typical example of how a physical concept or law is formed in physics as well as in natural science in general.

Concepts of physical quantities would change in time and become deeper with increasing understanding of nature. During the 20<sup>th</sup> century, our concepts of mass, acceleration and force have been greatly deepened through progress in physics. We shall briefly discuss some of the basic changes which are relevant to Newton's laws of motion and gravity.

First we will discuss the revolution in our concept of space and time. The concept of acceleration must heavily rely on the space-time concept. Newton regarded that the concept of space-time was well known to everybody and more or less given *a priori*. Instead, in the theory of special relativity (1905), Einstein carefully examined the space-time structure of the physical world based on the proposition that it is impossible to determine the absolute motion of a moving object. Einstein assumed that absolute speed of an object cannot be measured and only speed relative to some other objects or relative to an observer can be measured, that the speed of light in a vacuum is always the same no matter how fast the observer or light source is moving, and that the maximum velocity of any object that can be attained is the velocity of light.

Each observer sets up his/her own frame of reference, uses it to measure the position of a body in space, and obtains a different value from other observers for the position of the same body. Even the measured value of time for the same instantaneous event differs for different observers in general. Let us consider two observers moving with a constant velocity relative to each other. They observe a motion of the same body and compare the measured values of the position and time of the body at an instant of time with each other. The transformation from the values measured by one observer A to those measured by another observer B with uniform motion relative to A is called the Lorentz transformation.

In the theory of special relativity, if we denote the spatial and time coordinates of an event in frame A by  $x, y, z,$  and  $t$  the coordinates  $x', y', z', t'$  of the same event in frame B that moves past A at velocity  $v$  in the positive  $x$ -direction are given by

$$x' = \gamma(x - vt), y' = y, z' = z, t' = \gamma\left(t - \frac{xv}{c^2}\right) \quad (4)$$

where  $c$  is the light velocity and  $\gamma$  is

$$\gamma = \left(1 - v^2/c^2\right)^{-1/2} \quad (5)$$

We have chosen that the origins of A and B coincide at  $t = t' = 0$ . In Fig. 5 we show the two frames A and B.

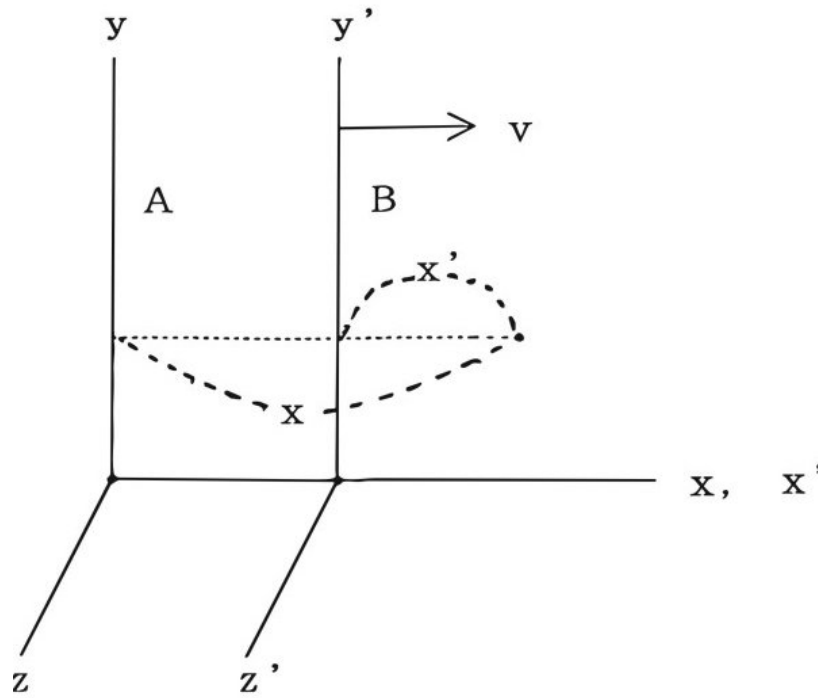

Figure 5. Two frames of reference in uniform motion relative to each other

The Lorentz transformation (Eq.(4)) is a linear transformation between the two sets of coordinates which leaves  $x^2 + y^2 + z^2 - c^2t^2$  invariant;

$$x^2 + y^2 + z^2 - c^2t^2 = x'^2 + y'^2 + z'^2 - c^2t'^2 \quad (6)$$

This means that light propagates with the same velocity  $c$  in both the frames of reference.

When the relative velocity  $v$  between the two frames is much less than that of light ( $v/c \ll 1$ ), Lorentz transformation reduces to the well known Galilean transformation of classical physics:

$$x' = x - vt, y' = y, z' = z, t' = t \quad (7)$$

and  $\gamma = 1$

Einstein first studied the validity of Maxwell's electromagnetic theory in reference frames in uniform motion relative to each other, and found that the theory is valid in all the frames. Thus, Maxwell's theory is invariant under Lorentz transformation and observers in uniform motion relative to each other find the same laws of the electromagnetism to hold. In 1887 Michelson and Morley found that the light velocity is exactly the same in every direction and does not depend on the actual motion of the earth. This contradicted the prediction of classical mechanics that a moving observer staying at the surface of the earth should find different light velocity depending upon the relative motion between the light source and the observer. This constancy of light velocity implied that the earth is at rest contrary to the accepted fact that the earth is moving about the sun.

Einstein's theory of special relativity solved the problem based on the proposition that the same physical laws must be valid in all frames of reference in uniform motion relative to each other. This means, in particular, that light must have the same speed no matter how an observer or light source is moving. If light is emitted from the origin at  $t = 0$  and moves at speed  $c$ , in frame A its motion is expressed by  $r = (x^2 + y^2 + z^2)^{1/2} = ct$ . Since  $r^2 - c^2t^2 = r'^2 - c^2t'^2$  (Eq. (6)) and  $r^2 - c^2t^2 = 0$ , we obtain  $r'^2 - c^2t'^2 = 0$ . This means that the light velocity is also equal to  $c$  in frame B ( $r' = ct$ ). Instead, if we use Galilean transformations, the light velocities  $c' (= dx'/dt')$  and  $c (= dx/dt)$  in frame B and A are related by  $c' = c - v$  and thus depend on the relative motion between the two frames of references, which contradicts the observations.

According to Lorentz transformation, even time depends on the velocity of an observer as shown in Eq.(4). Lorentz transformation treats time and space somewhat on equal footing and the time coordinate is not totally independent from the spatial coordinates.

In Galilean transformations the values of position and velocity of the same body at the same instant of time differ for different frames of reference in uniform motion relative to each other, but acceleration is the same for all the frames of reference. This explains why acceleration but not other kinematical quantities such as velocity, appears in Newton's equation of motion. Therefore, Newton's equation of motion is valid in any Galilean frame in uniform motion relative to others.

There are many peculiar predictions of the theory of special relativity, which are against our intuitive knowledge based on classical physics. For example, a moving body contracts in the direction of motion and a clock attached to a moving body ticks slower than a clock of an observer at rest. The magnitudes of these effects are of an order of the ratio of the velocity of the body to the light velocity squared and are negligibly small for motion of bodies in our daily experience. They become appreciably large only when a body is moving very fast with a velocity comparable to that of light. Furthermore, the theory predicts that any moving body cannot move faster than the light velocity whoever observes the motion of the body.

The velocity of light is about  $3 \times 10^8$  m/s, which is very large but finite. This finiteness of the light velocity has an important application in astronomical researches. We observe distant stars in the sky by collecting light emitted from them by using a telescope. Since the light velocity is finite, it takes time for light from distant stars to reach the earth. Thus, when we are looking at more distant stars in the sky, we are observing stars in more distant past. Therefore, if we look at extremely distant objects as far as possible, we can find out what happened in the early history of our universe or how the early universe looks like.

The concept of mass also changed due to the theory of special relativity. The mass  $m$  of a moving body with a constant velocity  $v$  relative to an observer does depend on the velocity and is given by  $m = m_0 \gamma$ , where  $m_0$  is the mass of the body at rest. If we try to accelerate a body, its mass will increase in proportion to  $\gamma$  with increasing velocity. As the velocity  $v$  approaches the light velocity, the mass and consequently the inertia for change of velocity will become infinitely large. This will make further acceleration of the body increasingly more difficult and thus the velocity of the body cannot exceed the light velocity. In the theory of relativity, mass is a kind of energy and the energy equivalence with mass is given by the famous formula  $E = mc^2$ . This Einstein's formula has been well proved experimentally through many physical processes in which a certain fraction of mass of a particle is converted into heat or some other kinds of energy. We shall derive the formula  $E = mc^2$ .

In a later chapter ( See *Physical Systems and Laws - Special and General Relativity*). The formula means that the concept of mass can be included in a wider concept of energy.

Next we shall discuss a revolutionary change in the concept of the gravity brought by Einstein's theory of general relativity (1916). As we described already, the mechanical mass in Newton's equation of motion and the gravitational mass in the law of gravity are numerically the same up to a great accuracy. If they are exactly the same, all bodies located near to each other get the same amount of acceleration due to the gravity there. Consider a large vessel containing various bodies as well as an observer in it as shown in Fig. 6. All the bodies including the observer in the vessel as well as the vessel itself fall freely with the same acceleration by earth's gravity. If the observer cannot see outside the vessel, he will find all the bodies being at rest or moving at a constant velocity relative to him and not being accelerated towards the bottom of the vessel. Namely, he would not notice presence of the gravity.

The reference coordinate system of the observer is an accelerated frame relative to the center of the earth. If we choose an adequately accelerated frame of reference such as one described above, we can completely eliminate the gravity locally. Since the magnitude and direction of the gravity are functions of space and time, we have to choose accelerated frames of reference as a function of space-time to eliminate the gravity everywhere. Such a coordinate system as a whole would be a curved coordinate system.



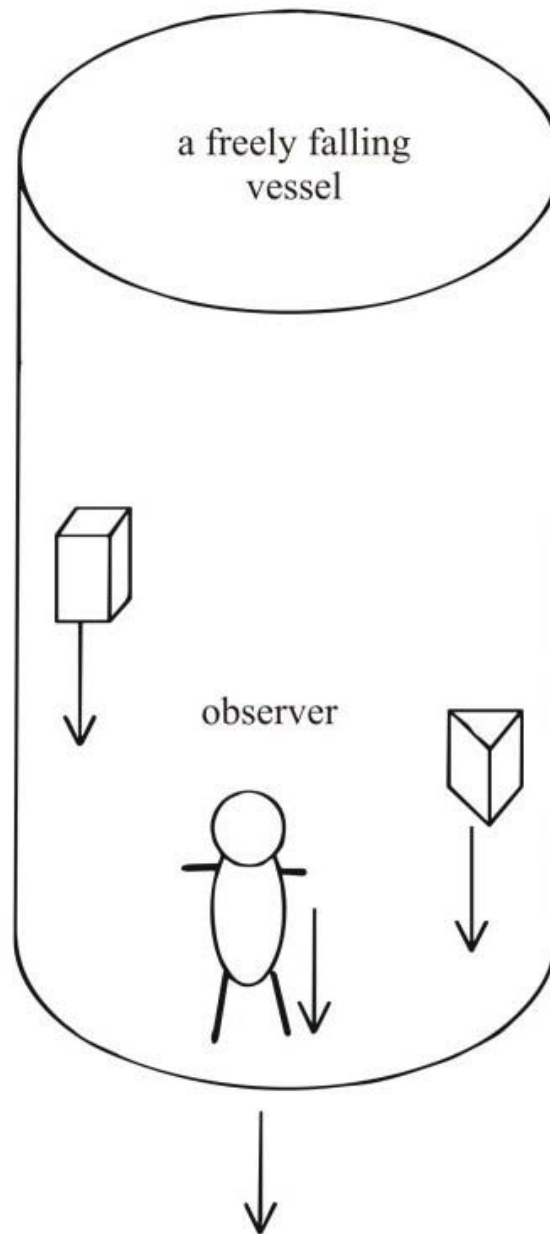

Figure 6. An accelerated frame of reference

Thus, the gravitational force is related to the curvature of our 4-dimensional space-time. In a curved space matter moves along a curved trajectory and the curvature of space is determined by presence of matter. These are equivalent to the facts that matter moves along a curved trajectory due to gravity and the gravity is determined by the presence of matter. In short, the theory of general relativity can be paraphrased as:

*Matter tells space how to bend, and space tells matter how to move.*

The general theory of relativity thus brought matter and space into intimate relations with each other. We shall discuss the theories of special and general relativity in a later chapter (see *Physical Systems and Laws - Special and General Relativity* ).

Finally, we shall mention our present knowledge on forces in general. The gravitational as well as electromagnetic forces act between two bodies apart. Both forces are action at a distance and follow the same inverse square law, gradually decreasing in strength with increasing distances. Other forces such as the nuclear force are also action at a distance. However, the nuclear force acts only at extremely short distances of the order of  $10^{-15}$  m and are negligibly weak at longer distances, thus are called action at a short distance.

There are some conceptual problems associated with action at a distance. If one of the bodies acting on each other changes its position, the strength of the force exerted on the other body would instantaneously change without any time delay, implying that the information of the position change propagates with infinite speed. If any information should be carried by some physical objects, the above instantaneous change contradicts the limiting speed of any object being the light velocity as predicted by the theory of special relativity.

Newton made no hypothesis as to how gravitational force can be transmitted through space. In the 16<sup>th</sup> and 17<sup>th</sup> centuries, the above conceptual problem involving action at a distance was temporarily solved by postulating some subtle media through which the action is transmitted, just like sound waves propagate through matter. These media are called *aethers*, while *ether* was used for the aether of electromagnetism. However, the gravitational force acts between distant objects through almost empty space and aethers were not found at all. Besides, Einstein's theory of relativity is not reconciled with existence of aethers.

By the middle of 19<sup>th</sup> century, Faraday introduced the concept of lines of electric and magnetic forces to explain various electromagnetic phenomena that he discovered. The concept implies that one can assign an electromagnetic field to every point in space and the field exists irrespective of the existence of any matter there. The mathematical equations for the electromagnetic field were formulated by Maxwell in 1860s, and Hertz's experiment in 1888 clearly showed that the electromagnetic forces are mediated by waves of the electromagnetic field through space. Likewise there exists the gravitational field associated with gravity, and the mathematical equations for the gravitational field were formulated by Einstein in his theory of general relativity. According to the theory, any change of gravity is mediated as waves of the gravitational field.

Quantum physics born in the early 20<sup>th</sup> century brought a revolutionary concept that any field is associated with its own quantum. The electromagnetic field has photons and the gravitational field has gravitons as their quanta. Because of an extremely small detection efficiency gravitons have not been experimentally observed yet, although their existence is well accepted by most physicists.

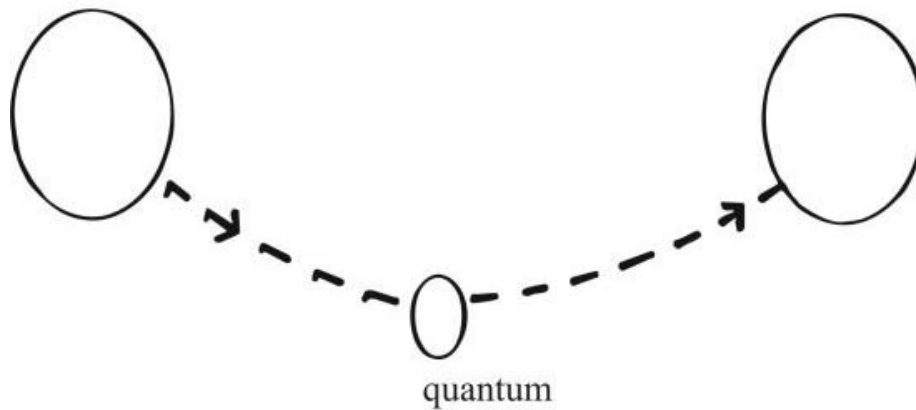

Figure 7. Force between two bodies due to exchange of a quantum

In modern physics, we assume that all kinds of force are mediated by particles which are quanta of the field of the force. When two bodies interact, either one of them emits a mediating quantum, the quantum propagates to the position of the other body, and then it is absorbed by the body. This completes the action between the two bodies. One can even show that any force mediated by a massless quantum such as a photon or a graviton follows the inverse square law. Also any force mediated by a massive quantum becomes action at a short distance. Fig. 7 shows how a force is mediated by exchange of a quantum between the interacting bodies.

Since any quantum propagates with a velocity not exceeding the velocity of light, any information about a change in a body or system cannot propagate to distant places faster than the velocity of light. This solved the problem inherent in action at a distance.

In this chapter we have described how concepts of physical quantities are formed and what physical laws mean. In the following articles, we will describe basic concepts and laws in classical mechanics, thermodynamics, acoustics, optics, and electromagnetism in some detail.

-  
-  
-

**TO ACCESS ALL THE 118 PAGES OF THIS CHAPTER,**  
Visit: <http://www.eolss.net/Eolss-sampleAllChapter.aspx>

### Bibliography

1.General Physics:

Condon E and Odishaw H (1958). Handbook of Physics. New York: McGraw Hill Book Co.

Lerner R and Trigg G (eds.) (1990). Encyclopedia of Physics. Weinheim and Berlin: Wiley VCH.

Hecht E (1980). *Physics in Perspective*. Reading, Massachusetts and London: Addison-Wesley Publishing Co.

Beiser A (1981). *Concepts of Modern Physics*. New York: McGraw-Hill Book Co.

Longair M (1984). *Theoretical Concepts in Physics*. Cambridge and New York: Cambridge University Press.

Bueche F (1986). *Introduction to Physics for Scientists and Engineers*. New York: McGraw-Hill Book Co.

Machlup S (1988). *Physics*. Chichester and New York: John Wiley and Sons, Inc.

Sternheim M and Kane J (1991). *General Physics*. Chichester and New York: John Wiley and Sons, Inc.

Halliday D and Resnick R (1992). *Physics*. Chichester and New York: John Wiley and Sons, Inc.

Ohanian H (1994). *Principles of Physics*. New York: W.W. Norton and Co.

Halliday D, Resnick K and Walker J (1997). *Fundamentals of Physics*. Chichester and New York: John Wiley and Sons, Inc.

Holbrow C, Lloyd J and Amato J (1998). *Modern Introductory Physics*. Berlin and New York: Springer.

## 2. Newtonian Mechanics:

Meriam J (1959). *Mechanics*. New York: Dover Publications, Inc.

Den Hartog J (1961). *Mechanics*. New York: Dover Publications, Inc.

H. Goldstein (1980). *Classical Mechanics* (2<sup>nd</sup> edition). Reading, Massachusetts and London: Addison-Wesley Publishing Co.

Feynman R, Leighton R and Sands M (1963). *Lectures on Physics-Mainly Mechanics*. Reading, Massachusetts and London: Addison-Wesley Publishing Co.

Kittel C, Knight W and Ruderman M (1965). *Mechanics, Berkley Physics Course Volume I*. New York: McGraw-Hill Book Co.

Klepper D (1973). *An Introduction to Mechanics*. New York: McGraw-Hill Book Co.

Landau L and Lifshitz E (1976). *Mechanics*. Oxford and New York: Pergamon Press.

Percival I and Richards D (1982). *Introduction of Dynamics*. Cambridge: Cambridge University Press.

Chow T (1996). *Classical Mechanics*. Chichester and New York: John Wiley and Sons, Inc.

## 3. Thermodynamics:

Reif F (1965). *Fundamentals of Statistical and Thermal Physics*. New York: McGraw-Hill Book Co.

Kittel C (1971). *Thermal Physics*. Chichester and New York: John Wiley and Sons, Inc.

Brush S (1976). *The Kind of Motion We call Heat*. Amsterdam: North-Holland Ltd.

Schmidt F, Henderson R and Wolgemuth C (1993). *Introduction to Thermal Sciences*. Chichester and New York: John Wiley and Sons, Inc.

Espinola T (1994). *Introduction to Thermodynamics*. New York: McGraw-Hill Book Co.

#### 4. Optics and Acoustics:

Newton I (1952). *Optics: A Treatise of the Reflections, Refractions and Colours of Light*. New York: Dover Publications, Inc.

Crawford F (1968). *Waves, Berkley Physics Course, Volume 3*. New York: McGraw-Hill Book Co.

Smith F and Thomson J(1973). *Optics*, Chichester and New York: John Wiley and Sons, Inc.

Jenkins A and White H (1976). *Fundamentals Optics*. New York: McGraw-Hill Book Co.

Klein M and Furtak T (1986). *Optics*. Chichester and New York: John Wiley and Sons, Inc.

Born M and Wold E (1990). *Principles of Optics*. (7<sup>th</sup> edition). Cambridge: Cambridge University Press.

Stuart J and Rayleigh B(1945). *Theory of Sound*. New York: Dover Publications.

Kinsler L and Frey A (1982). *Fundamentals of Acoustics*. Chichester and New York: John Wiley and Sons, Inc.

#### 5. Electricity and Magnetism:

Maxwell J (1954). *A Treatise on Electricity and Magnetism*. New York: Dover Publications.

McKeehan L (1967). *Magnets*. Princeton: D. Van Nostrand Company, Inc.

Slator J and Frank N (1969). *Electromagnetism*. New York: Dover Publications.

Landau L and Lifshitz E (1984). *Electrodynamics of Continuous Media*. Oxford and New York: Pergamon Press.

Nayfeh M (1985). *Electricity and Magnetism*. Chichester and New York: John Wiley and Sons, Inc.

Purcell E (1985). *Electricity and Magnetism*. Berkley Physics Course, Volume 2. New York: McGraw-Hill Book Co.

Grant I and Phillips W (1990). *Electromagnetism*. Chichester and New York: John Wiley and Sons, Inc.

Greiner W (1991). *Classical Electrodynamics*. New York and Berlin: Springer-Verlag.

Craik D (1995). *Magnetism: Principles and Applications*. Chichester and New York: John Wiley and Sons, Inc.

Jackson J (1998). *Classical Electrodynamics (the third edition)*. Chichester and New York: John Wiley and Sons, Inc.

#### **Biographical Sketch**

**Gyo Takeda**, Professor Emeritus of Tokyo University and Tohoku University, was born in Tokyo 1924. His speciality is the theory of Particle physics and nuclear physics and he also carries out research into neuroscience. He is known as one of the collaborators of Prof. S. Tomonaga's works on the relativistic renormalized theory of quantum electrodynamics. After graduating from Physics Department, University of Tokyo, he has served as an Associate professor, Kobe University, Professor and Director, Institute for Nuclear Studies, University of Tokyo, Professor of Physics and Dean of Faculty of Science, Tohoku University, and a Professor, General Education, Tohoku Gakuin University. Also he served as a research associate of University of Wisconsin and Brookhaven National Laboratory, USA, during the period of

1952-1955 and as a visiting professor of University of Wisconsin and University of California, Berkley, during the period of 1961-1963. He was a member of High Energy Physics Committee of IUPAP(International Union of Pure and Applied Physics) during the period of 1973-1978 and served as the Chairman of the Organizing Committee of the 17th International High Energy Physics Conference held in Tokyo, 1978. He has published many textbooks on general physics, quantum field theory, particle physics, and neuroscience all in Japanese.

UNESCO - EOLSS  
SAMPLE CHAPTERS